

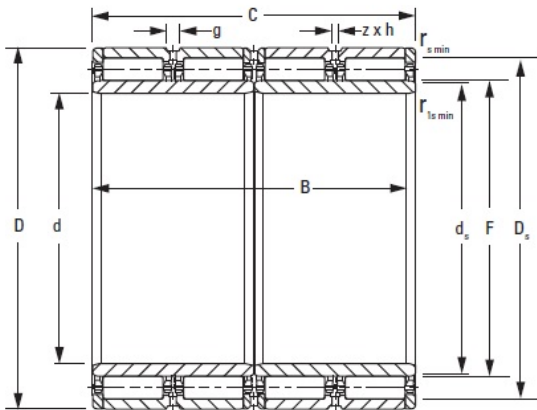

Ldpd Double Row Inc



370RX2045 TIMKEN TAPERED ROLLER BEARINGS

Bearing No. 370RX2045

370RX2045 Bearing 2D drawings and 3D CAD models

Bore d	370.000 mm
O.D. D	520.000 mm
Width B	380.000 mm
Width C	380.000 mm
DUR/DOR F/E	409.000 mm
Type	RX-1
Static Load Rating C_0	6500 kN
Dynamic Load Rating C_1^1	14040 kN
Weight	565.300 lb
Chamfer r_{smin}	1.50 mm
Chamfer r_{1smin}^2	10.0 mm
Angle of Chamfer r_{1smin}	20 °
Backing Shaft Diameter d_s	401.0 mm
Backing Housing Diameter D_s	485.0 mm
Lubrication Groove g	16.0 mm
Lubrication Hole Diameter h	7.5 mm
Number of Lubrication Holes	10
Inner-Ring Set	370ARXS2045
Outer-Ring Set	409RXS2045