

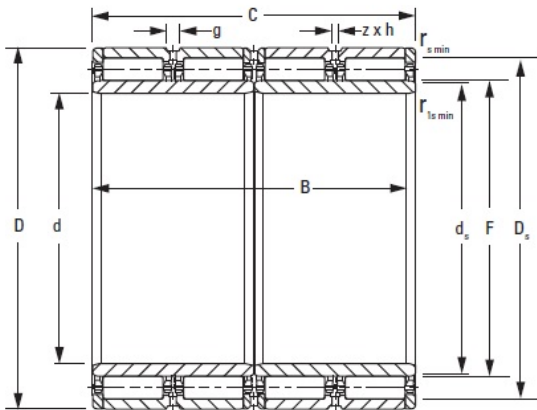

# Ldpd Double Row Inc



## 390RX2088 TIMKEN TAPERED ROLLER BEARINGS

Bearing No. 390RX2088

390RX2088 Bearing 2D drawings and 3D CAD models

Bore d	390.000 mm
O.D. D	540.000 mm
Width B	320.000 mm
Width C	320.000 mm
DUR/DOR F/E	431.000 mm
Type	RX-1
Static Load Rating $C_0$	5540 kN
Dynamic Load Rating $C_1^1$	11440 kN
Weight	492.400 lb
Chamfer $r_{smin}$	2.00 mm
Chamfer $r_{1smin}^2$	10.0 mm
Angle of Chamfer $r_{1smin}$	20 °
Backing Shaft Diameter $d_s$	422.4 mm
Backing Housing Diameter $D_s$	509.0 mm
Lubrication Groove g	15.0 mm
Lubrication Hole Diameter h	7.5 mm
Number of Lubrication Holes	16
Inner-Ring Set	390ARXS2088
Outer-Ring Set	431RXS2088