

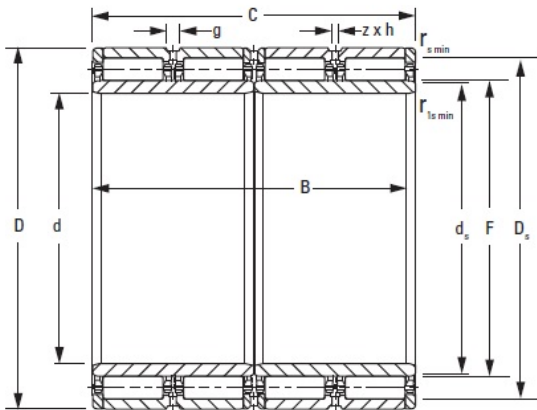

# Ldpd Double Row Inc



## 440RX2245 TIMKEN TAPERED ROLLER BEARINGS

Bearing No. 440RX2245

440RX2245 Bearing 2D drawings and 3D CAD models

Bore d	440.000 mm
O.D. D	620.000 mm
Width B	450.000 mm
Width C	450.000 mm
DUR/DOR F/E	487.000 mm
Type	RX-1
Static Load Rating $C_0$	9100 kN
Dynamic Load Rating $C_1^1$	20200 kN
Weight	965.300 lb
Chamfer $r_{smin}$	4.00 mm
Chamfer $r_{1smin}^2$	12.0 mm
Angle of Chamfer $r_{1smin}$	20 °
Backing Shaft Diameter $d_s$	477.4 mm
Backing Housing Diameter $D_s$	577.0 mm
Lubrication Groove g	16.0 mm
Lubrication Hole Diameter h	7.5 mm
Number of Lubrication Holes	8
Inner-Ring Set	440ARXS2245
Outer-Ring Set	487RXS2245