

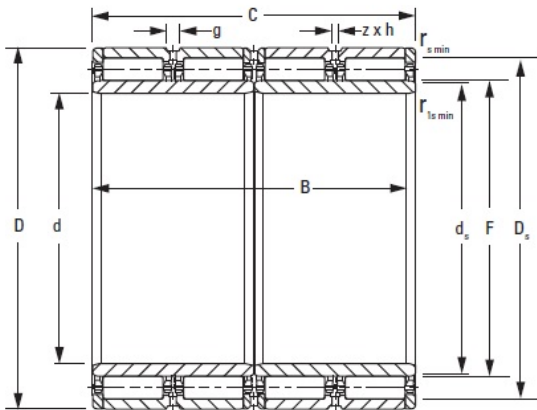

Ldpd Double Row Inc



380RX2087 TIMKEN TAPERED ROLLER BEARINGS

Bearing No. 380RX2087

380RX2087 Bearing 2D drawings and 3D CAD models

Bore d	380.000 mm
O.D. D	540.000 mm
Width B	400.000 mm
Width C	400.000 mm
DUR/DOR F/E	422.000 mm
Type	RX-1
Static Load Rating C_0	6900 kN
Dynamic Load Rating C_1^1	14760 kN
Weight	655.100 lb
Chamfer r_{smin}	2.00 mm
Chamfer r_{1smin}^2	10.0 mm
Angle of Chamfer r_{1smin}	20 °
Backing Shaft Diameter d_s	412.8 mm
Backing Housing Diameter D_s	502.0 mm
Lubrication Groove g	16.0 mm
Lubrication Hole Diameter h	8.0 mm
Number of Lubrication Holes	8
Inner-Ring Set	380ARXS2087
Outer-Ring Set	422RXS2087