

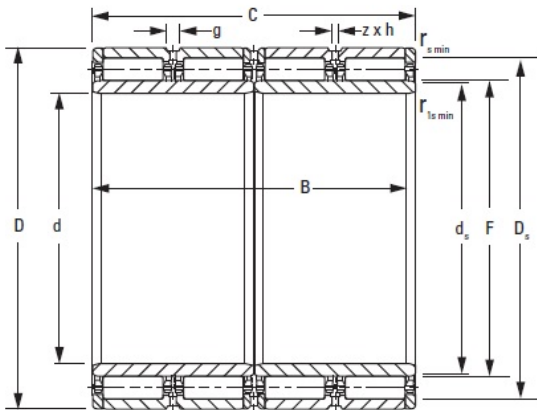

Ldpd Double Row Inc



550RX2484 TIMKEN TAPERED ROLLER BEARINGS

Bearing No. 550RX2484

550RX2484 Bearing 2D drawings and 3D CAD models

Bore d	550.000 mm
O.D. D	740.000 mm
Width B	510.000 mm
Width C	510.000 mm
DUR/DOR F/E	600.000 mm
Type	RX-1
Static Load Rating C_0	11780 kN
Dynamic Load Rating C_1^1	28400 kN
Weight	1389.700 lb
Chamfer r_{smin}	2.00 mm
Chamfer r_{1smin}^2	15.0 mm
Angle of Chamfer r_{1smin}	20 °
Backing Shaft Diameter d_s	588.5 mm
Backing Housing Diameter D_s	698.0 mm
Lubrication Groove g	22.0 mm
Lubrication Hole Diameter h	12.0 mm
Number of Lubrication Holes	16
Inner-Ring Set	550ARXS2484
Outer-Ring Set	600RXS2484