

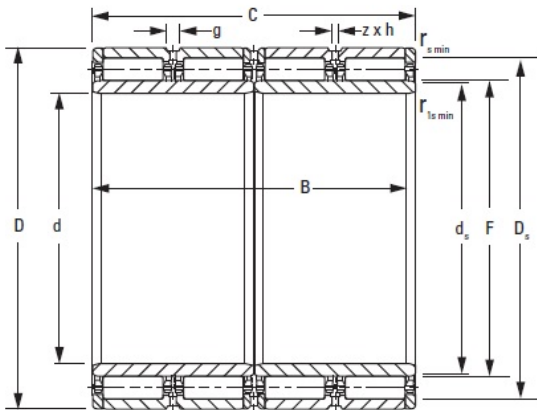

Ldpd Double Row Inc



460RX2371 TIMKEN TAPERED ROLLER BEARINGS

Bearing No. 460RX2371

460RX2371 Bearing 2D drawings and 3D CAD models

Bore d	460.000 mm
O.D. D	685.000 mm
Width B	400.000 mm
Width C	400.000 mm
DUR/DOR F/E	518.000 mm
Type	RX-1
Static Load Rating C_0	8780 kN
Dynamic Load Rating C_1^1	15880 kN
Weight	1167.100 lb
Chamfer r_{smin}	3.00 mm
Chamfer r_{1smin}^2	11.0 mm
Angle of Chamfer r_{1smin}	20 °
Backing Shaft Diameter d_s	508.4 mm
Backing Housing Diameter D_s	638.0 mm
Lubrication Groove g	18.0 mm
Lubrication Hole Diameter h	9.0 mm
Number of Lubrication Holes	12
Inner-Ring Set	460ARXS2371
Outer-Ring Set	518RXS2371