

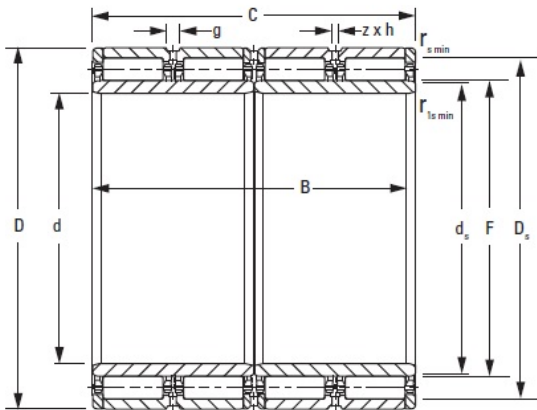

Ldpd Double Row Inc



571RX2622 TIMKEN TAPERED ROLLER BEARINGS

Bearing No. 571RX2622

571RX2622 Bearing 2D drawings and 3D CAD models

Bore d	571.100 mm
O.D. D	812.970 mm
Width B	594.000 mm
Width C	594.000 mm
DUR/DOR F/E	636.000 mm
Type	RX-1
Static Load Rating C_0	15440 kN
Dynamic Load Rating C_1^1	35000 kN
Weight	2220.400 lb
Chamfer r_{smin}	5.00 mm
Chamfer r_{1smin}^2	14.0 mm
Angle of Chamfer r_{1smin}	20 °
Backing Shaft Diameter d_s	623.3 mm
Backing Housing Diameter D_s	758.0 mm
Lubrication Groove g	25.3 mm
Lubrication Hole Diameter h	13.0 mm
Number of Lubrication Holes	16
Inner-Ring Set	571ARXS2622
Outer-Ring Set	636RXS2622