

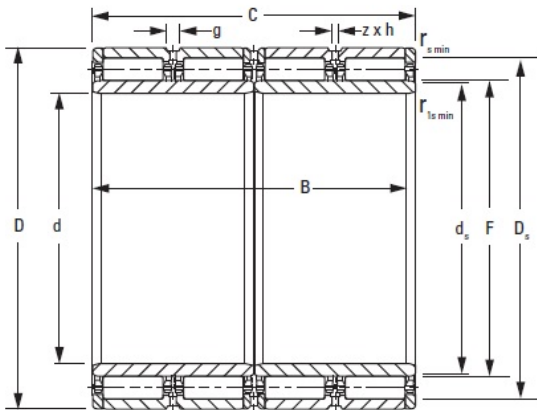

Ldpd Double Row Inc



530RX2522 TIMKEN TAPERED ROLLER BEARINGS

Bearing No. 530RX2522

530RX2522 Bearing 2D drawings and 3D CAD models

Bore d	530.000 mm
O.D. D	760.000 mm
Width B	520.000 mm
Width C	520.000 mm
DUR/DOR F/E	587.000 mm
Type	RX-1
Static Load Rating C_0	13080 kN
Dynamic Load Rating C_1^1	27680 kN
Weight	1731.800 lb
Chamfer r_{smin}	5.00 mm
Chamfer r_{1smin}^2	12.0 mm
Angle of Chamfer r_{1smin}	20 °
Backing Shaft Diameter d_s	576.0 mm
Backing Housing Diameter D_s	707.0 mm
Lubrication Groove g	19.3 mm
Lubrication Hole Diameter h	9.5 mm
Number of Lubrication Holes	12
Inner-Ring Set	530ARXS2522
Outer-Ring Set	587RXS2522